

BM: 6' splice of 6" St. Herrington Ave.  
E.W. 112.90

NOTE: All work embodied on these plans shall be done in conformity with applicable provisions of specifications M2271.

Recess curb for driveways where necessary. Exact location and width to be determined in field.

Street name signs and standards shall be removed and relocated as directed by the Engineer. Footings shall be class B concrete, same size as on original installation.

Legend: \* To be removed under this contract.  
o To be relocated by others.

pavement in area shown thus [hatched] to be removed and replaced with plant mixed surfacing, joining gutter and existing pavement to grade.

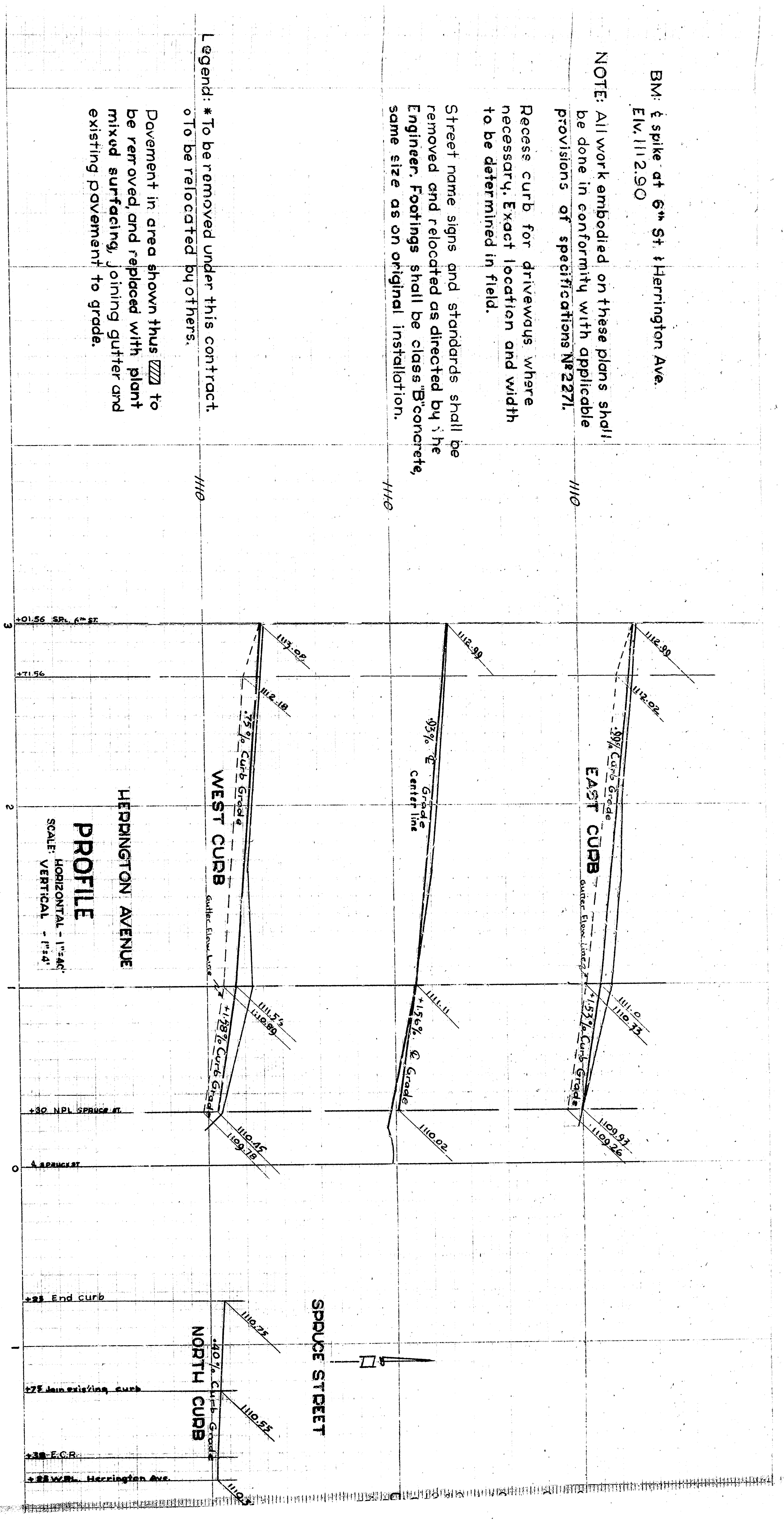

HERRINGTON AVENUE  
PROFILE  
SCALE: HORIZONTAL - 1"=40'  
VERTICAL - 1"=4'

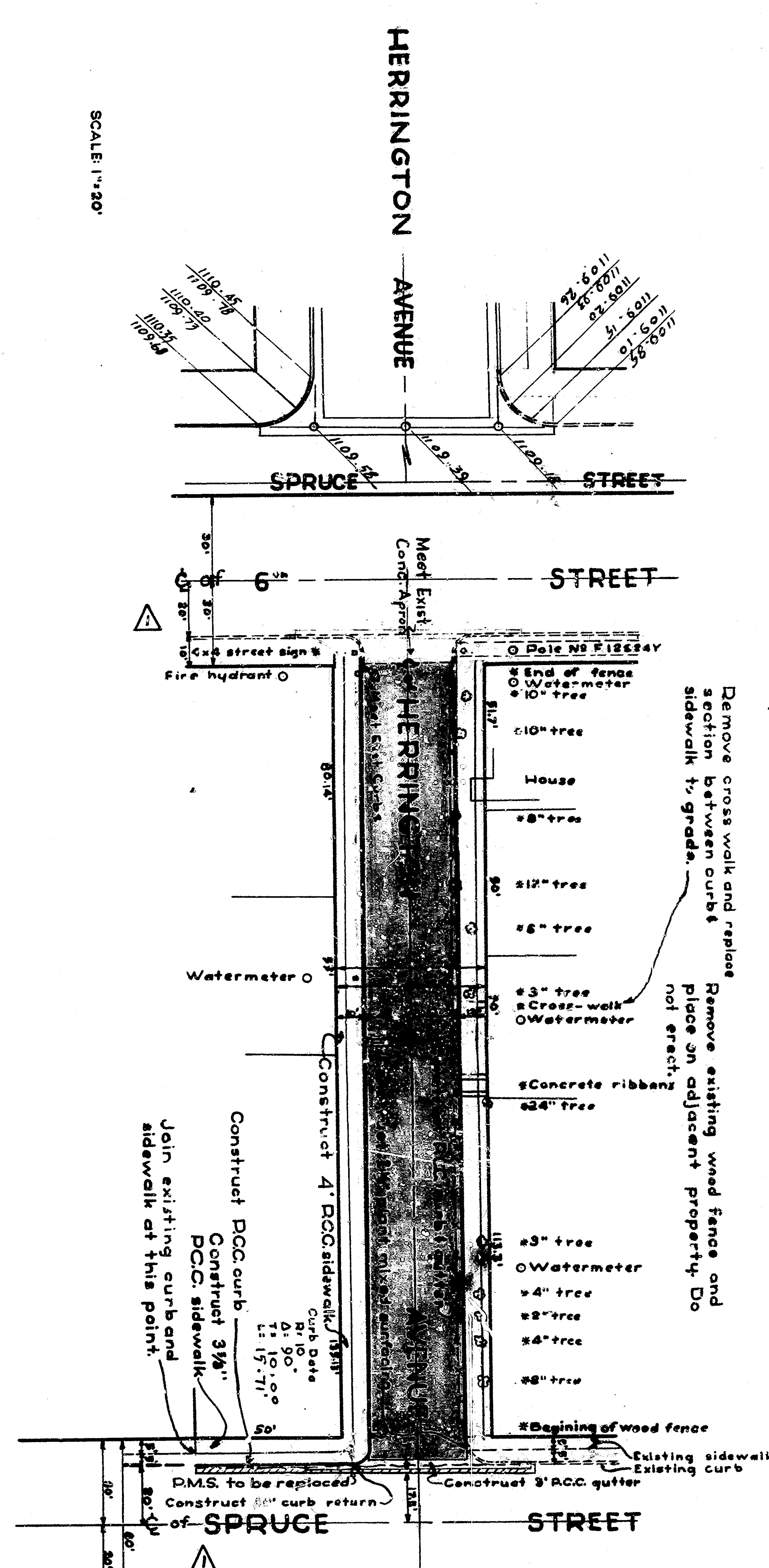

NO.	BY	REVISION	APPROVED	DATE
1	CLC	Include curb return reduction in contract	[Signature]	March 98
2	BT		[Signature]	April 98

TYPICAL CROSS-SECTION  
HERRINGTON AVENUE  
SCALE: 1"=4'

COMBINATION CURB  
& GUTTER SECTION  
SCALE: 1"=4'

TYPICAL CROSS-SECTION  
SPRUCE STREET  
NO SCALE

CURB, GUTTER, PAVING and SIDEWALKS  
HERRINGTON AVENUE - SPRUCE ST - 6" ST.  
CURB and SIDEWALKS  
SPRUCE STREET - HERRINGTON AVENUE  
HERRINGTON AVE TO A POINT 20 WEST  
Job No 98

May 98  
7043  
2300

BM: 6" spike at 6" St Herrington Ave.  
 E.W. 11/2/50

NOTE: All work embodied on these plans shall be done in conformity with applicable provisions of specifications M2271.

Recess curb for driveways where necessary. Exact location and width to be determined in field.

Street name signs and standards shall be removed and relocated as directed by the Engineer. Footings shall be class B concrete, same size as on original installation.

Legend: \* To be removed under this contract.  
 o To be relocated by others.

pavement in area shown thus [hatched] to be removed and replaced with plant mixed surfacing, joining gutter and existing pavement to grade.

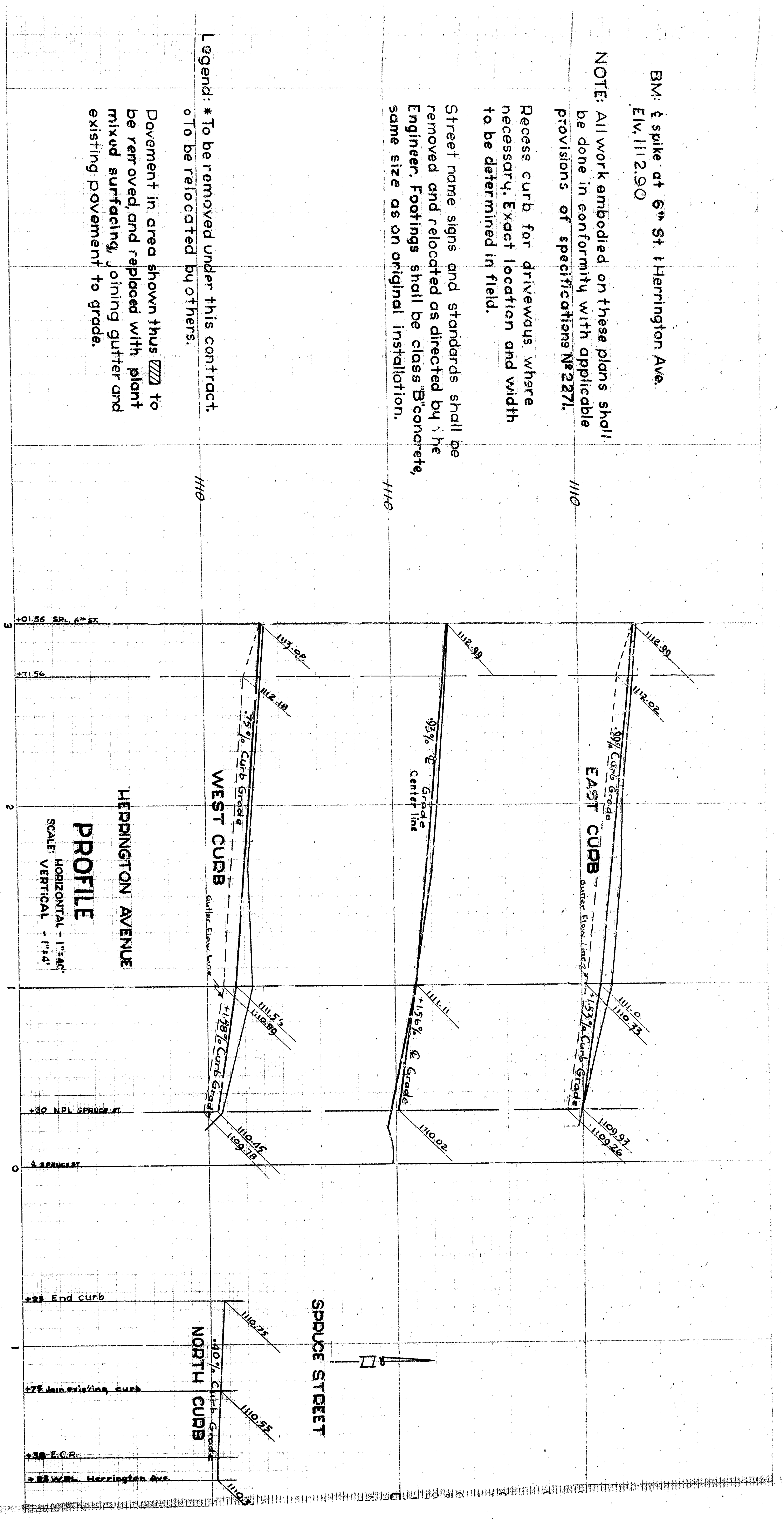

HERRINGTON AVENUE  
 PROFILE  
 SCALE: HORIZONTAL - 1"=40'  
 VERTICAL - 1"=4'

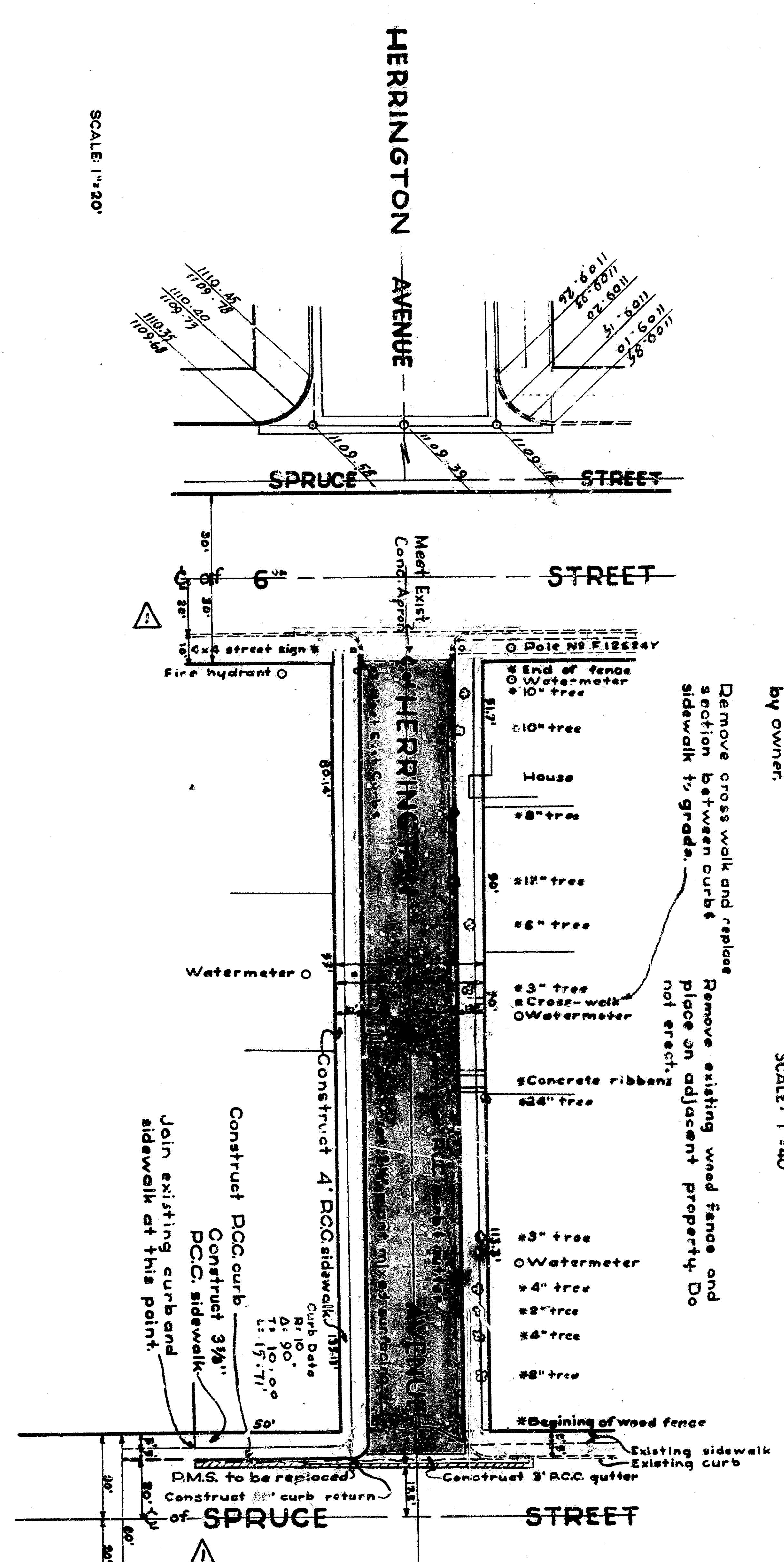

PLAN  
 SCALE: 1"=40'

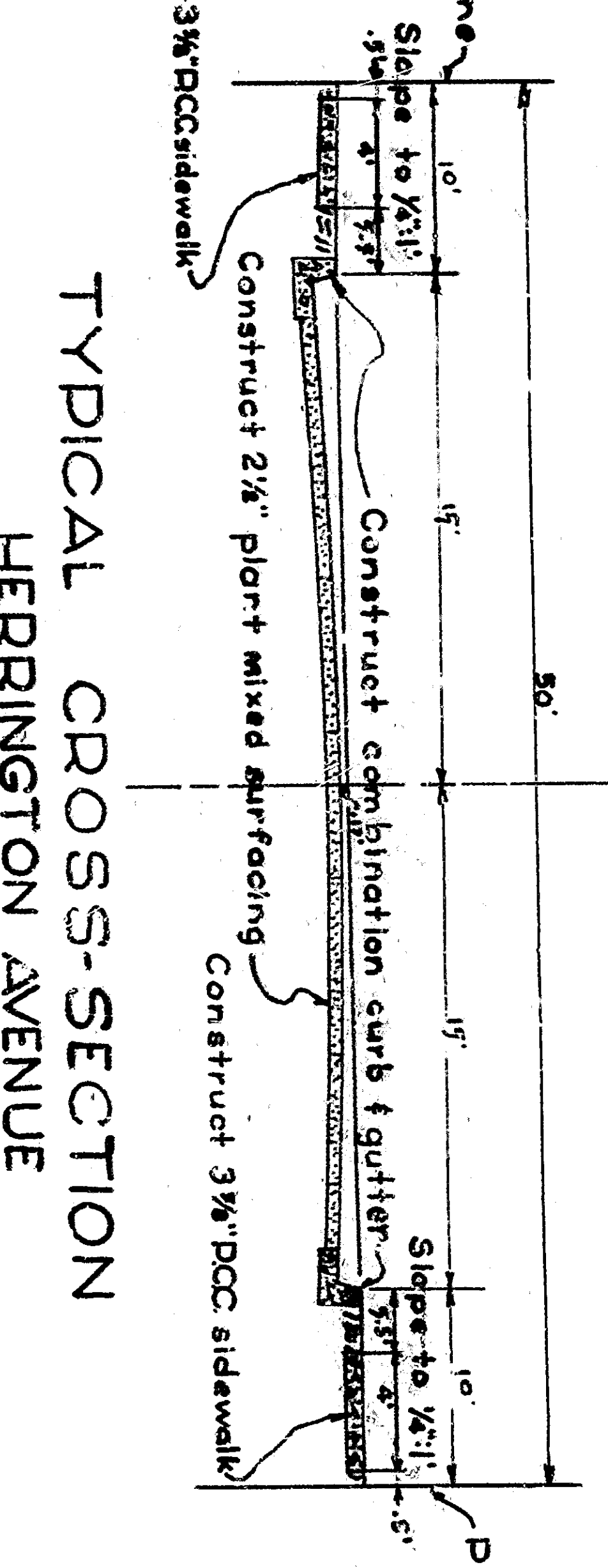
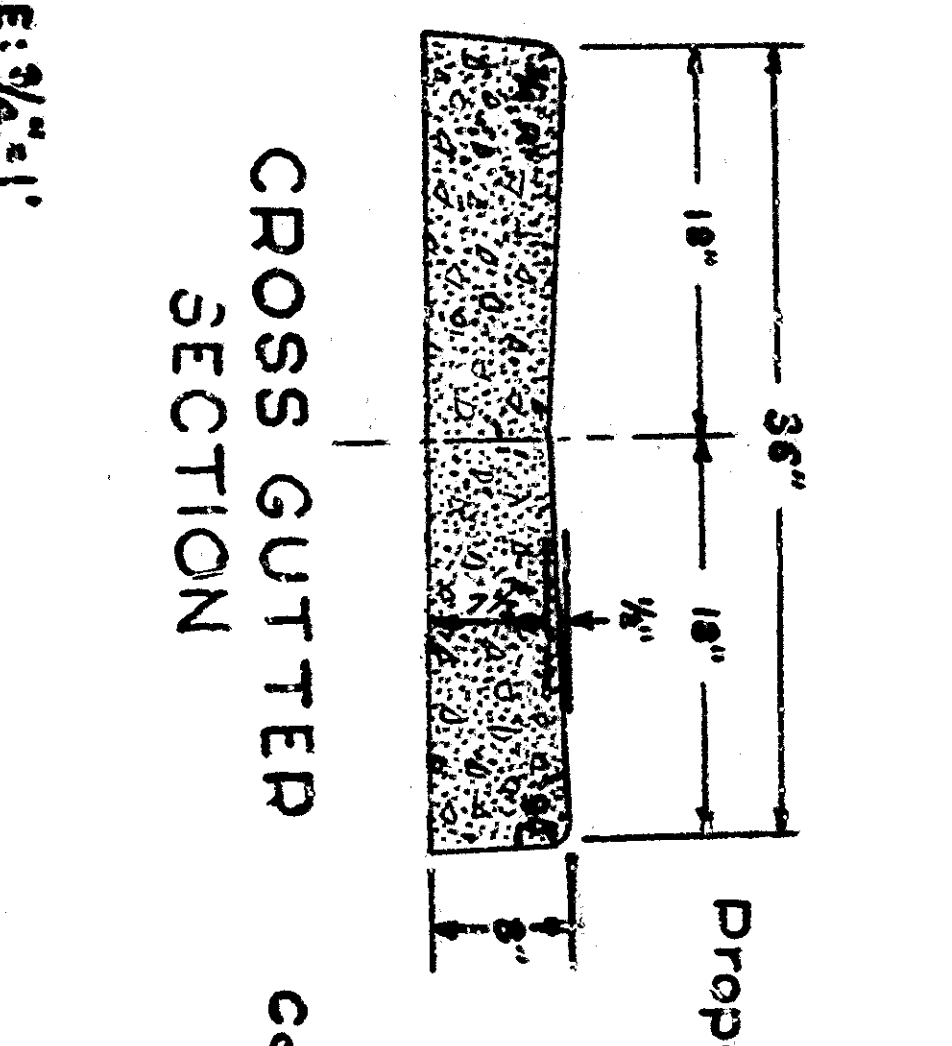
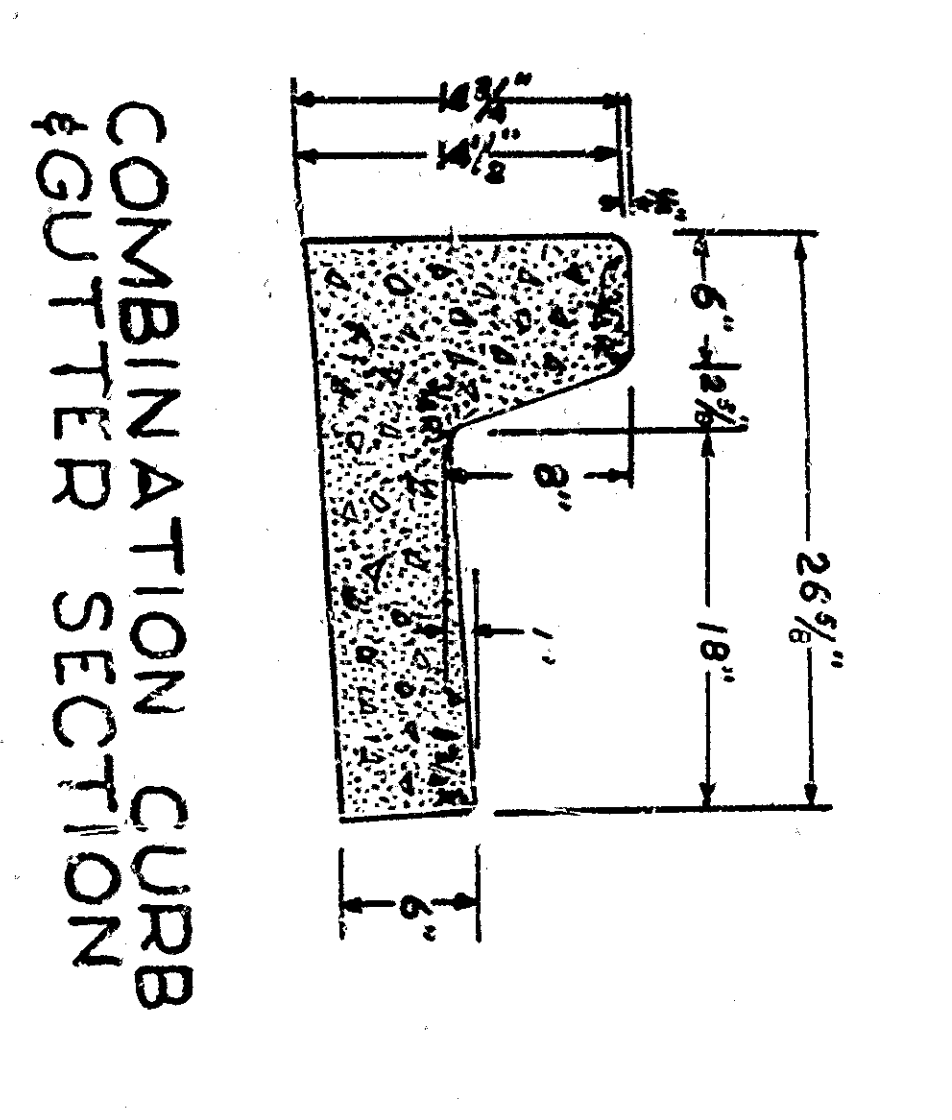

NO.	BY	REVISION	APPROVED	DATE
1	CLC	Include curb return reduction in contract	[Signature]	11/2/50
2	BT		[Signature]	11/2/50

CURB, GUTTER, PAVING and SIDEWALKS  
 HERRINGTON AVENUE - SPRUCE ST - 6" ST  
 CURB AND GUTTER PROPERTY LINE  
 SPRUCE STREET TO A POINT 20 WEST  
 HERRINGTON AVE TO A POINT 20 WEST

Job No 98

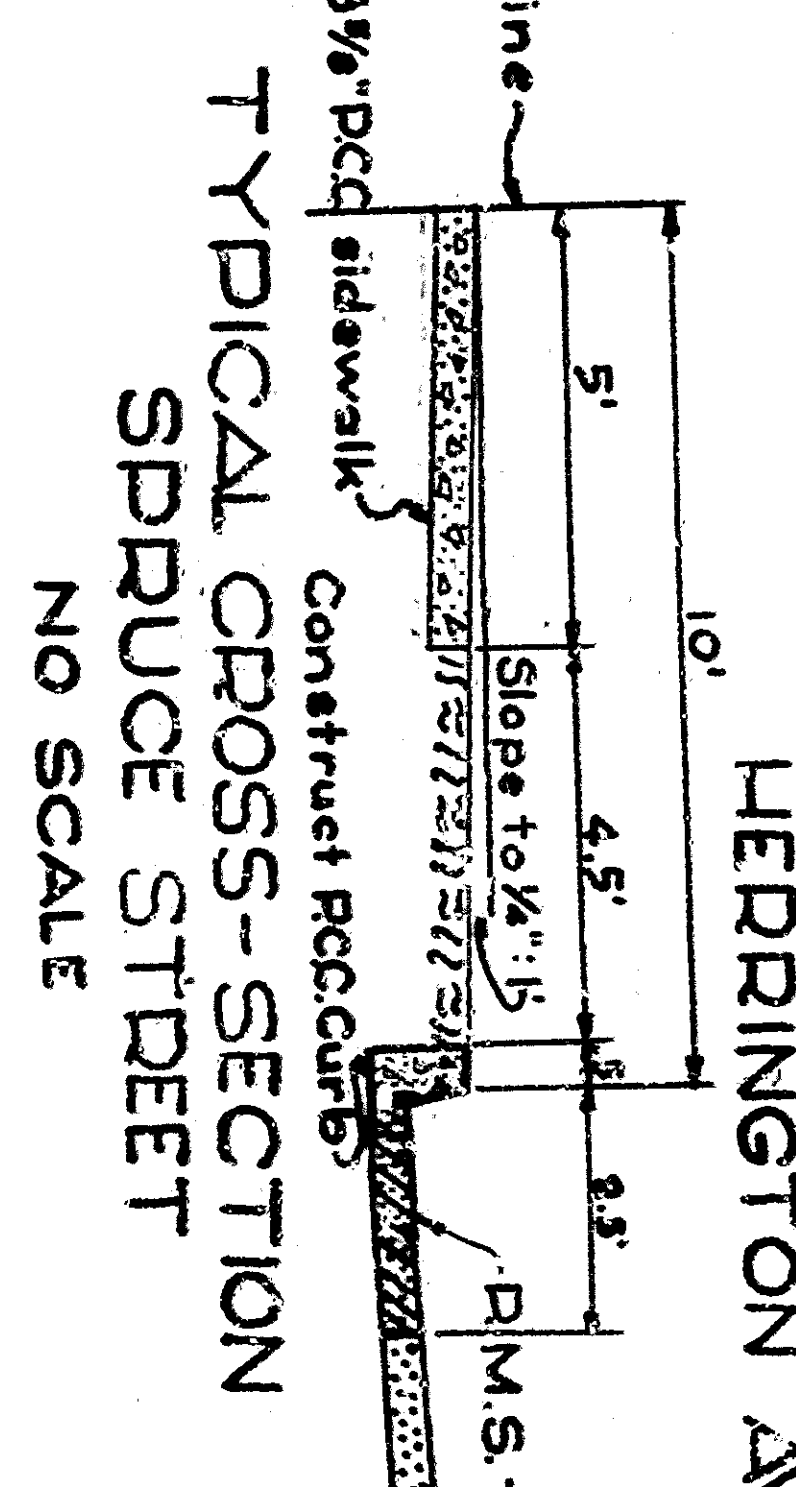
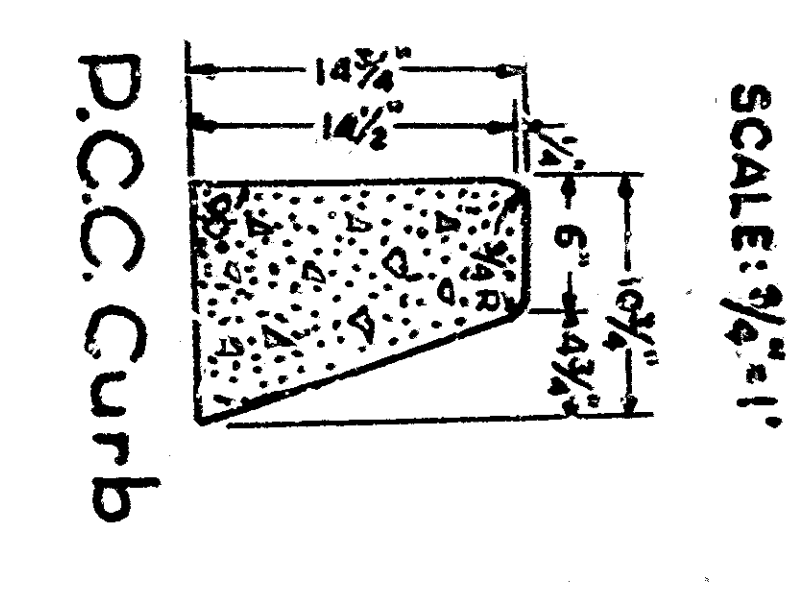

DATE: May 9, 55  
 7043  
 2300